



Staff Selection Commission
(Government Of India)

REGISTRATION NUMBER : 2402002964
EXAM DATE : 9-September-2016
EXAM NAME : SSC Examination 2016
TOTAL MARKS : 200

CANDIDATE NAME : VINEET
EXAM START TIME : 16:15:00
EXAM DURATION : 01:15 Hrs
TOTAL NO OF QUESTIONS : 100

Question 1. Select the related word/letters/numbers from the given alternatives:

दिये गये विकल्पों में से संबंधित शब्द/अक्षरों/संख्या को चुनिए।

Star : Telescope :: Ship : ?

Options:

1) Periscope

परिदर्शी

2) Microscope

सूक्ष्मदर्शी

3) Deck

डेक

4) Gyroscope

घूर्णाक्षस्थापी

(जायरोस्कोप)

Correct Answer: Periscope

परिदर्शी

Candidate Answer: Periscope

परिदर्शी

Question 2. Select the related word/letters/numbers from the given alternatives:

दिये गये विकल्पों में से संबंधित शब्द/अक्षरों/संख्या को चुनिए।

QSUW : TVXZ :: ACEG : ?

Options:

1) KMNP

2) EGMN

3) DFHJ

4) FHIL

Correct Answer: DFHJ

Candidate Answer: DFHJ

Question 3. Select the related word/letters/numbers from the given alternatives:

दिये गये विकल्पों में से संबंधित शब्द/अक्षरों/संख्या को चुनिए।

12 : 54 :: 15 : ?

Options:

1) 56

2) 64

3) 67

4) 69

Correct Answer: 69

Candidate Answer: 69

Question 4.

For the following questions

Find the odd word/letters/number from the given alternatives

दिए गए विकल्पों में से विषम शब्द/अक्षर/संख्या चुनिये।

Options:

- 1) Wolf
भेडिया
- 2) Cat
बिल्ली
- 3) Dog
कुत्ता
- 4) Fox
लोमड़ी

Correct Answer: Cat
बिल्ली

Candidate Answer: Wolf
भेडिया

Question 5.

For the following questions

Find the odd word/letters/number pair from the given alternatives

दिए गए विकल्पों में से विषम शब्द/अक्षर/संख्या युग्म चुनिये।

Options:

- 1) BF
- 2) LR
- 3) MQ
- 4) AE

Correct Answer: LR

Candidate Answer: LR

Question 6.

For the following questions

Find the odd word/letters/number pair from the given alternatives

दिए गए विकल्पों में से विषम शब्द/अक्षर/संख्या युग्म चुनिये।

Options:

- 1) 36-72
- 2) 17-34
- 3) 28-49
- 4) 24-48

Correct Answer: 28-49

Candidate Answer: 28-49

Question 7. Arrange the following words as per ordering the dictionary:

निम्नलिखित शब्दों को शब्दकोश में दिए गए क्रम के अनुसार लिखें।

- 1) ASSIGN
- 2) ASSOCIATE
- 3) ASSIST
- 4) ASSISTANT
- 5) ASSIGNMENT

Options:

- 1) 1,5,3,4,2
- 2) 1,3,5,4,2
- 3) 1,3,5,2,4
- 4) 1,5,2,4,3

Correct Answer: 1,5,3,4,2

Candidate Answer: 1,5,3,4,2

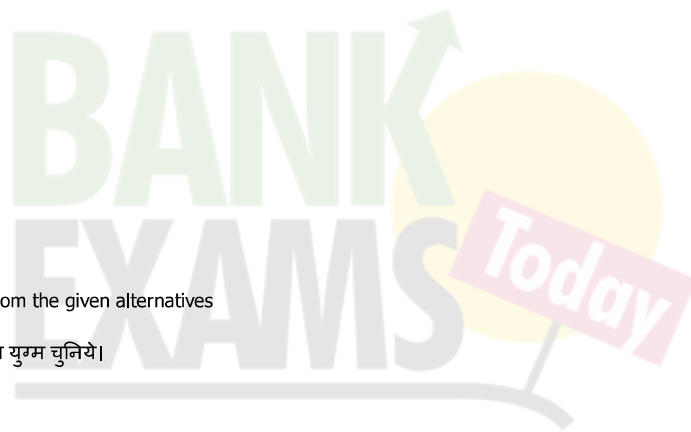

Question 8.A series is given, with one term missing. Choose the correct alternative from the given ones that will complete the series:

दिये गये अनुक्रम में एक पद लुप्त है। दिए गए विकल्पों में से वह सही विकल्प चुनिये जो अनुक्रम को पूरा करे।

FED , IHG , LKJ , ONM , ?

Options:

1) MKJ

2) VUT

3) CBA

4) RQP

Correct Answer: RQP

Candidate Answer: RQP

Question 9.A series is given, with one term missing. Choose the correct alternative from the given ones that will complete the series:

दिये गये अनुक्रम में एक पद लुप्त है। दिए गए विकल्पों में से वह सही विकल्प चुनिये जो अनुक्रम को पूरा करे।

3,4,7,?,18,29,47

Options:

1) 8

2) 9

3) 11

4) 12

Correct Answer: 11

Candidate Answer: 11

Question 10.Pointing the lady in the photograph, Seema said, "Her son's father is the son-in-law of my mother". How is Seema related to the lady?

फोटो में एक स्त्री की ओर इशारा करते हुए सीमा ने कहा, " उसके पुत्र के पिता मेरी माँ के दामाद है।" सीमा का उस फोटो वाली स्त्री से सम्बन्ध बताएँ ?

Options:

1) Sister

बहन

2) Mother

माँ

3) Cousin

चचेरा/चचेरी/ममेरी/फुफेरी/मौसेरी बहन

4) Aunt

चाची

Correct Answer: Sister

बहन

Candidate Answer: Sister

बहन

Question 11.P, Q, R, S & T are sitting in a straight line facing North. P sits next to S but not to T. Q is sitting next to R who sits on the entrance left corner. Who sits to the left of S if T does not sit next to Q?

P, Q, R, S और T उत्तर की ओर मुख करके सीधी रेखा में बैठे हैं। P,S के बाद बैठा है किन्तु T के नहीं। Q, R के बाद बैठा है जो कि आखिरी में बायें कोने पर है। यदि T,Q के बाद नहीं बैठता है तो बताइए S के बायें ओर कौन बैठा है ?

Options:

1) P

2) Q

3) R

4) T

Correct Answer: P

Candidate Answer: T

Question 12.From the given alternative words, select the word which cannot be formed using the letters of the given word:

निम्नलिखित विकल्पों में से वह शब्द चुनिए जो दिए गए शब्द के अक्षरों का प्रयोग करके नहीं बनाया जा सकता:

EXPERIMENTAL

Options:

1) PARENT

2) RELAX

3) METER

4) METHANE

Correct Answer: METHANE

Candidate Answer: METHANE

Question 13.If E=5, PEN=35, then PAGE=?

यदि E=5, PEN=35 हो, तो PAGE=?

Options:

1) 27

2) 28

3) 29

4) 30

Correct Answer: 29

Candidate Answer: 29

Question 14.If '+' means '÷', '÷' means '-', '-' means 'X' and 'X' means '+', then

यदि '+' से आशय '÷' से हो, '÷' से आशय '-' से हो, '-' से आशय 'X' से हो और 'X' से आशय '+', से हो तो:

$48 + 16 \times 4 - 2 \div 8 = ?$

Options:

1) 3

2) 6

3) 112

4) -28

Correct Answer: 3

Candidate Answer: 3

Question 15.Some equations have been solved on the basis of a certain pattern. Find the correct answer for the unsolved equation on that basis:

कुछ समीकरणों का हल किसी विशिष्ट पैटर्न के अनुसार निकाला गया है। उसी आधार पर उन समीकरणों का हल निकालें जिनका हल नहीं निकाला गया है ?

$7*4*3 = 437$

$8*6*4=648$

$4*3*6=?$

Options:

1) 346

2) 364

3) 643

4) 463

Correct Answer: 364

Candidate Answer: 364

Question 16.Select the missing number from the given matrix:

दिए गए आव्यूह में से लुप्त अंक जात कीजिए।

5	2	4
4	4	7
2	5	3
18	30	?

Options:

1) 43

2) 42

3) 33

4) 32

Correct Answer: 33

Candidate Answer: 33

Question 17. A boy runs 20 m towards East and turns to right, runs 10 m and turns to right, runs 9 m and again turns to left, runs 5 m and turns to left, runs 12 m and finally turns to left and runs 6m. Now, which direction is the boy facing?

एक लड़का 20 मी. पूर्व की ओर दौड़ता है और फिर दायें मुड़ कर 10 मी. दौड़ता है। फिर दायें मुड़कर 9 मी. दौड़ता है और फिर बायें मुड़ कर 5 मी. दौड़ता है तथा फिर बायें मुड़कर 12 मी. दौड़ता है और अन्ततः बायें मुड़कर 6 मी. दौड़ता है। अब उस लड़के के चेहरे के सामने कौन-सी दिशा है ?

Options:

- 1) East
पूर्व
- 2) West
पश्चिम
- 3) North
उत्तर
- 4) South
दक्षिण

Correct Answer: North

उत्तर

Candidate Answer: East

पूर्व

Question 18. Consider the given statement/s to be true and decide which of the given conclusions/assumptions can definitely be drawn from the given statement.

Statement:I All astronomers are scientists.

Statement:II Some scientists are shopkeepers.

Conclusion:I All astronomers are shopkeepers.

Conclusion:II Some shopkeepers are astronomers.

Conclusion:III Some shopkeepers are scientists.

Conclusion:IV All scientists are astronomers.

निम्नलिखित प्रश्न में एक या दो वक्तव्य दिये गये हैं, जिसके आगे चार निष्कर्ष/मान्यताएं, I, II, III और IV निकाले गये हैं। आपको विचार करना है कि वक्तव्य सत्य है चाहे वह सामान्यतः जात तथ्यों से भिन्न प्रतीत होता हो। आपको निर्णय करना है कि दिए गए वक्तव्य में से कौन-सा निश्चित रूप से सही निष्कर्ष/मान्यता निकाला जा सकता है ?

वक्तव्य I : सभी खगोलशास्त्री, वैज्ञानिक हैं।

वक्तव्य II : कुछ वैज्ञानिक दुकानदार हैं।

निष्कर्ष: I सभी खगोलशास्त्री दुकानदार हैं।

निष्कर्ष:II कुछ दुकानदार खगोलशास्त्री हैं।

निष्कर्ष:III कुछ दुकानदार वैज्ञानिक हैं।

निष्कर्ष:IV सभी वैज्ञानिक खगोलशास्त्री हैं।

Options:

- 1) Only I conclusion follows
केवल I निष्कर्ष निकलता है
- 2) Conclusions I, II and III follows
निष्कर्ष I, II और III निकलते हैं
- 3) Only conclusion III follows
केवल III निष्कर्ष निकलता है
- 4) Conclusion II and IV follows
निष्कर्ष II और IV निकलते हैं

Correct Answer: Only conclusion III follows

केवल III निष्कर्ष निकलता है

Candidate Answer: Only conclusion III follows

केवल III निष्कर्ष निकलता है

Question 19. How many points will be there on the face opposite to the face with 2 points?

जिस पृष्ठ पर 2 बिन्दु है उसके ठीक सामने वाले पृष्ठ पर कितने बिन्दु होंगे ?

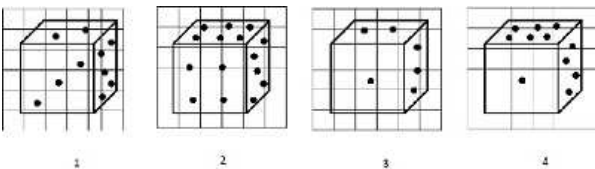

Options:

- 1) 1
- 2) 5
- 3) 4
- 4) 6

Correct Answer: 6

Candidate Answer: 6

Question 20. Which figure represents the relationship among -
Computer skilled, Computer Illiterate, Employees

निम्नलिखित में से कौन-सी आकृति 'कम्प्यूटर-कुशल', 'कम्प्यूटर-निरक्षर', 'कर्मचारियों' को दर्शाती है ?

Options:

1)

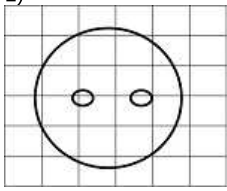

2)

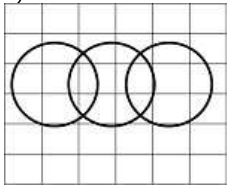

3)

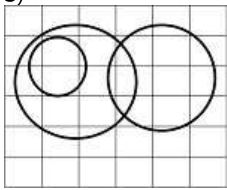

4)

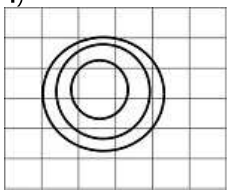

Correct Answer:

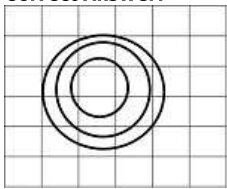

Candidate Answer:

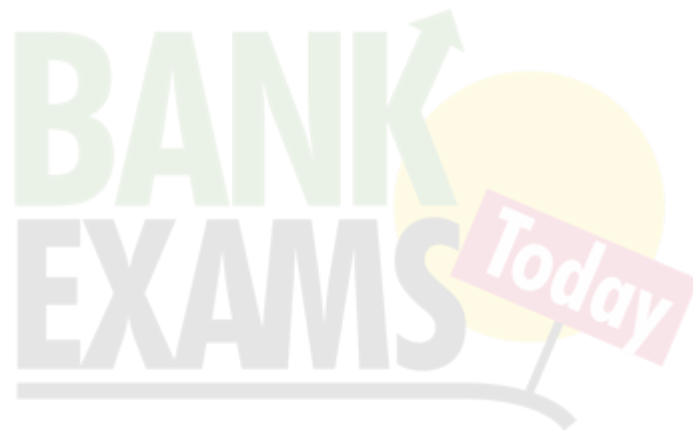
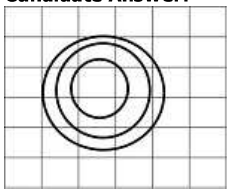

Question 21. Which answer figure will complete the figure in the question figure?

कौन-सी उत्तर आकृति प्रश्न आकृति के प्रतिरूप को पूरा करेगी ?

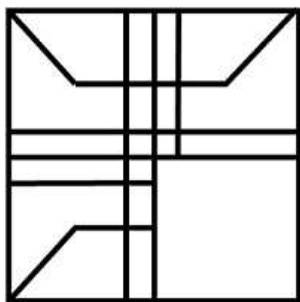

Options:

1)

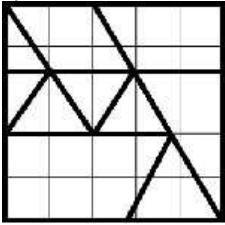

2)

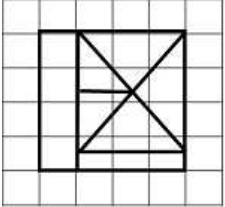

3)

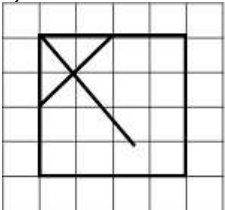

4)

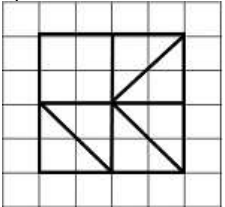

Correct Answer:

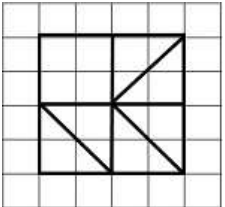

Candidate Answer:

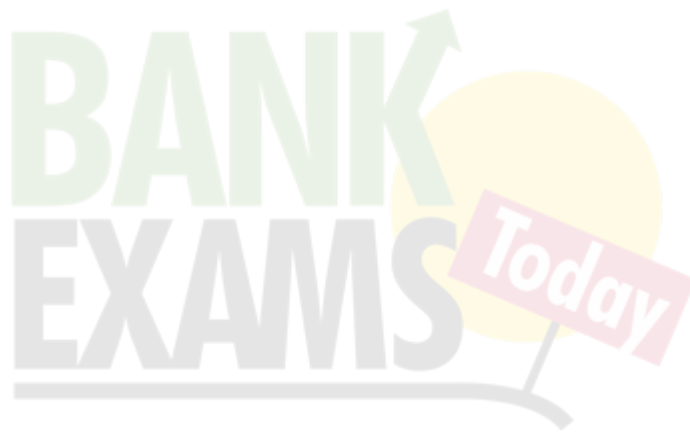
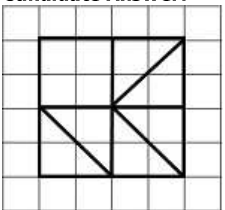

Question 23. A piece of paper is folded and cut as shown below in the question figures. From the given answer figures, indicate how it will appear when opened.

नीचे प्रश्न आकृतियों में दिखाए अनुसार कागज को मोड़कर काटने तथा खोलने के बाद वह किस उत्तर आकृति जैसा दिखाई देगा ?

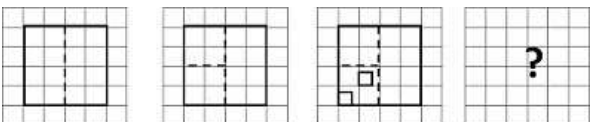

Options:

1)

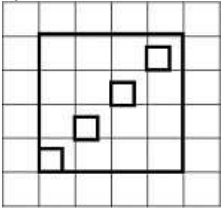

2)

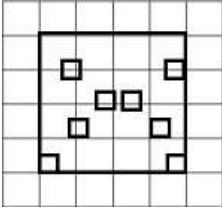

3)

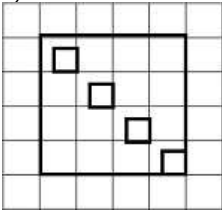

4)

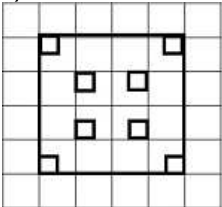

Correct Answer:

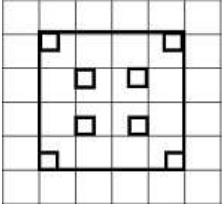

Candidate Answer:

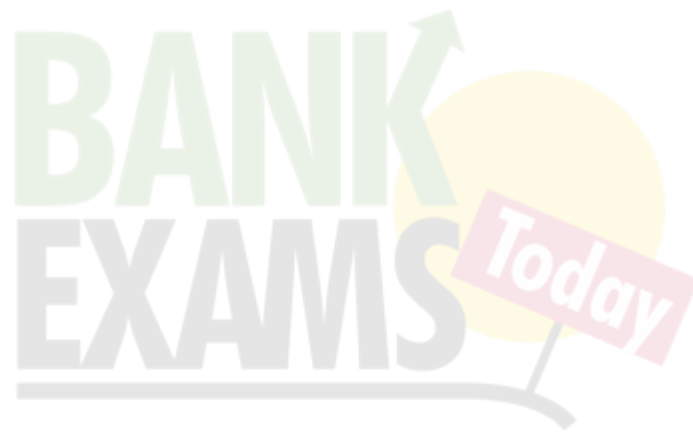
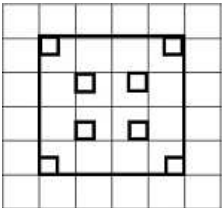

Question 24. If a mirror is placed on the line MN, then which of the answer figures is the right image of the given figure?

यदि एक दर्पण को MN रेखा पर रखा जाये तो दी गई उत्तर आकृतियों में से कौन-सी आकृति प्रश्न आकृति की सही प्रतिबिम्ब होगी ?

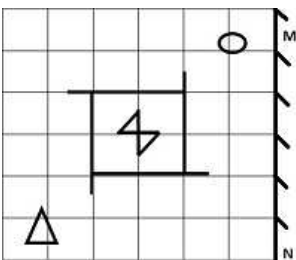

Options:

1)

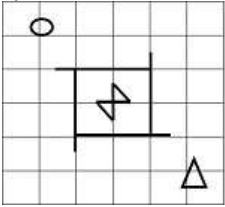

2)

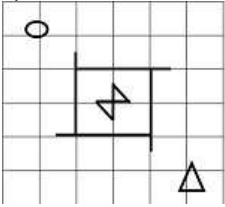

3)

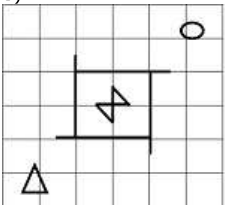

4)

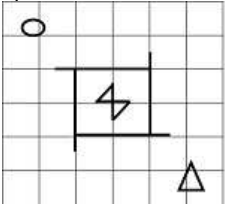

Correct Answer:

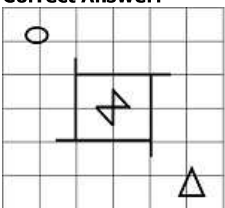

Candidate Answer:

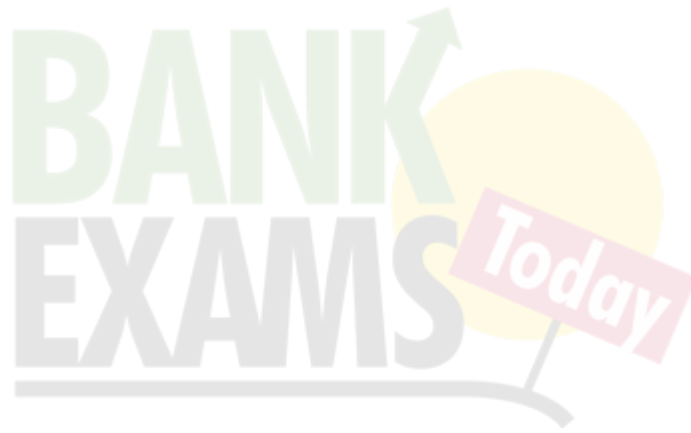
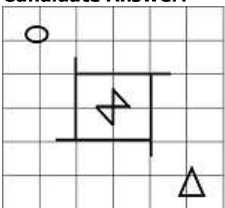

Question 25. In the question, a word is represented by only one set of numbers as given in any one of the alternatives. The sets of numbers given in the alternatives are represented by two classes of alphabets as in two matrices given below. The columns and rows of Matrix I are numbered from 0 to 4 and that of Matrix II are numbered from 5 to 9. A letter from these matrices can be represented first by its row and next by its column, e.g., 'G' can be represented by 04,40, etc., and 'K' can be represented by 56, 68, etc. Similarly, you have to identify the set for the word 'LIFE'.

एक शब्द केवल एक संख्या-समूह द्वारा दर्शाया गया है, जैसा कि विकल्पों में से किसी एक में दिया गया है। विकल्पों में दिए गए संख्या-समूह अक्षरों के वर्गों द्वारा दर्शाए गए हैं, जैसा कि नीचे दिए गए दो आव्यूहों में है। आव्यूह I के स्तम्भ और पंक्ति की संख्या 0 से 4 और आव्यूह II की 5 से 9 दी गई है। इन आव्यूहों से एक अक्षर को पहले उसकी पंक्ति और बाद में स्तम्भ द्वारा दर्शाया जा सकता है। उदाहरण के लिए, 'G' को 04,40 आदि द्वारा दर्शाया जा सकता है तथा 'K' को 56,68 आदि द्वारा दर्शाया जा सकता है। इसी तरह से आपको दिए शब्द 'LIFE' के लिए आव्यूह को पहचानना है।

	0	1	2	3	4		5	6	7	8	9
0	C	D	E	F	G	5	H	K	L	I	N
1	F	G	C	D	E	6	I	N	H	K	L
2	D	E	F	G	C	7	K	L	I	N	K
3	E	F	G	C	D	8	L	I	N	H	K
4	G	C	D	E	F	9	N	H	K	L	I

Options:

- 1) 56,58,03,02
- 2) 57,65,03,02
- 3) 66,62,03,02
- 4) 57,68,10,02

Correct Answer: 57,65,03,02**Candidate Answer:** 57,65,03,02

Question 26. Which of the following brings out the 'Consumer Price Index Number' for Industrial workers?

उद्योग-कर्मियों के लिए ' उपभोक्ता मूल्य सूचकांक संख्या' निम्नलिखित में से कौन प्रतिपादित करता है ?

Options:

- 1) RBI
भारतीय रिज़र्व बैंक
- 2) The Labour Bureau
श्रम ब्यूरो
- 3) Commerce Department
वाणिज्य विभाग
- 4) NITI Ayog
नीति आयोग

Correct Answer: The Labour Bureau

श्रम ब्यूरो

Candidate Answer: RBI

भारतीय रिज़र्व बैंक

Question 27. The basis of determining dearness allowance to employees in India is _____

भारत में कर्मचारियों हेतु महँगाई भत्ता तय करने का आधार _____ है।

Options:

- 1) National Income
राष्ट्रीय आय
- 2) Consumer Price Index
उपभोक्ता मूल्य सूचकांक
- 3) Standard of Living
रहन-सहन का स्तर
- 4) Inflation Rate
मुद्रास्फीति की दर

Correct Answer: Consumer Price Index

उपभोक्ता मूल्य सूचकांक

Candidate Answer: Consumer Price Index

उपभोक्ता मूल्य सूचकांक

Question 28. An indifference curve measures the same level of _____

उदासीनता वक्र _____ के समान स्तर को मापता है।

Options:

- 1) Output from two factors
दो कारकों के उत्पाद
- 2) Satisfaction from two commodities
दो वस्तुओं से प्राप्त संतुष्टि
- 3) Satisfaction from Income and Capital
आय व पूँजी से प्राप्त संतुष्टि
- 4) Satisfaction from expenditure and savings
व्यय तथा बचत से प्राप्त होने वाली संतुष्टि

Correct Answer: Satisfaction from two commodities

दो वस्तुओं से प्राप्त संतुष्टि

Candidate Answer: [NOT ANSWERED]

Question 29. The largest committee of Parliament of India is

भारतीय संसद की सबसे बड़ी कमेटी कौन सी है ?

Options:

- 1) Public Accounts Committee
लोक लेखा समिति
- 2) Estimates Committee
प्राक्कलन समिति
- 3) Committee on Public Undertakings
सार्वजनिक उपक्रम समिति
- 4) Joint Parliamentary Committee
संयुक्त संसदीय समिति

Correct Answer: Estimates Committee
प्राक्कलन समिति

Candidate Answer: [NOT ANSWERED]

Question 30. Which of the following State has bicameral legislature?

निम्नलिखित में से किस राज्य का विधानमंडल द्विसदनीय है ?

Options:

- 1) Tamil Nadu
तमिल नाडू
- 2) Punjab
पंजाब
- 3) Sikkim
सिक्किम
- 4) Jammu and Kashmir
जम्मू व कश्मीर

Correct Answer: Jammu and Kashmir
जम्मू व कश्मीर

Candidate Answer: Jammu and Kashmir
जम्मू व कश्मीर

Question 31. Cod liver oil from fish is rich in which vitamin?

मछली से प्राप्त होने वाला कॉड लिवर तेल किस विटामिन से समृद्ध होता है ?

Options:

- 1) Vitamin A
विटामिन A
- 2) Vitamin D
विटामिन D
- 3) Vitamin C
विटामिन C
- 4) Vitamin B
विटामिन B

Correct Answer: Vitamin D
विटामिन D

Candidate Answer: Vitamin A
विटामिन A

Question 32. Isolines joining places of equal rainfall are called _____

समान वर्षा वाले स्थानों को मिलाने वाली समरेखाओं को _____ कहते हैं ।

Options:

- 1) isohyets
आइसोहाइट
- 2) isotherms
आइसोथर्म
- 3) isobars
आइसोबार
- 4) contours
कंटूर

Correct Answer: isohyets
आइसोहाइट

Candidate Answer: contours
कंटूर

Question 33. The Swadeshi Boycott Movement is related to

स्वदेशी आंदोलन का सम्बन्ध किससे है ?

Options:

- 1) Partition of Bengal in 1947
1947 में बंगाल के विभाजन
- 2) Partition of Bengal in 1905
1905 में बंगाल के विभाजन
- 3) Non cooperation movement in 1921
1921 के असहयोग आंदोलन
- 4) Partition of Punjab in 1947
1947 में पंजाब के विभाजन

Correct Answer: Partition of Bengal in 1905
1905 में बंगाल के विभाजन

Candidate Answer: Non cooperation movement in 1921
1921 के असहयोग आंदोलन

Question 34. Which river does not form a delta?

निम्नलिखित में से कौन सी नदी का मुहाना (डेल्टा) नहीं है ?

Options:

- 1) Ganga
गंगा
- 2) Brahmaputra
ब्रह्मपुत्र
- 3) Godavari
गोदावरी
- 4) Tapi
तापी

Correct Answer: Tapi
तापी

Candidate Answer: Tapi
तापी

Question 35. Babita Kumari represented India in the Rio Olympics 2016 in which sport?

2016 के रियो ओलंपिक में बबीता कुमारी भारत का प्रतिनिधित्व किस खेल में कर रही है ?

Options:

- 1) Boxing
मुक्केबाजी
- 2) Wrestling
कुश्ती
- 3) Hockey
हॉकी
- 4) Badminton
बैडमिंटन

Correct Answer: Wrestling
कुश्ती

Candidate Answer: Wrestling
कुश्ती

Question 36. Which one of the following is commonly used for pulp bleaching in the paper industry?

कागज उद्योग में लुगदी को रंगहीन करने के लिए निम्नलिखित में से सामान्यतः किसका प्रयोग किया जाता है ?

Options:

- 1) Mild sulphuric acid
हल्के सल्फ्यूरिक एसिड का
- 2) Glucose isomerase
ग्लूकोज आइसोमेरेस का
- 3) Hydrogen peroxide
हाइड्रोजन पेरोक्साइड का
- 4) Iodine and water
आयोडीन व पानी का

Correct Answer: Hydrogen peroxide
हाइड्रोजन पेरोक्साइड का

Candidate Answer: [NOT ANSWERED]

Question 37. The official language of the Delhi Sultanate was?

दिल्ली सल्तनत की राजकीय भाषा क्या थी ?

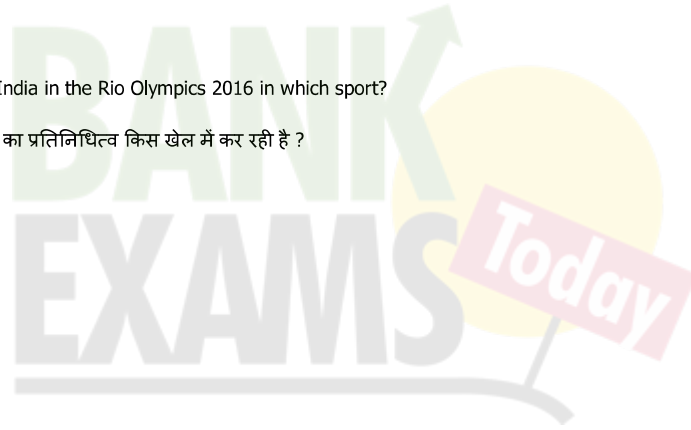

Options:

- 1) Urdu
उर्दू
- 2) Arabic
अरबी
- 3) Persian
फारसी
- 4) Hindi
हिन्दी

Correct Answer: Persian
फारसी

Candidate Answer: Urdu
उर्दू

Question 38. Yeast is a _____

यीस्ट एक _____ है।

Options:

- 1) Bacteria
जीनाणु
- 2) Fungi
कवक
- 3) Algae
शैवाल
- 4) Bryophyte
ब्रायोफाइट

Correct Answer: Fungi
कवक

Candidate Answer: Bryophyte
ब्रायोफाइट

Question 39. Mutiny of 1857 was described as the First Indian War of Independence by

1857 के विद्रोह को भारत के प्रथम स्वतन्त्रता संग्राम की संज्ञा किसने प्रदान की ?

Options:

- 1) Bal Gangadhar Tilak
बाल गंगाधर तिलक
- 2) Subhash Chandra Bose
सुभाष चन्द्र बोस
- 3) Bhagat Singh
भगत सिंह
- 4) V. D. Savarkar
वी. डी. सावरकर

Correct Answer: V. D. Savarkar
वी. डी. सावरकर

Candidate Answer: V. D. Savarkar
वी. डी. सावरकर

Question 40. Bandhavgarh National Park is located in which State?

बान्धवगढ़ राष्ट्रीय उद्यान किस राज्य में है ?

Options:

- 1) Maharashtra
महाराष्ट्र
- 2) Madhya Pradesh
मध्य प्रदेश
- 3) Gujarat
गुजरात
- 4) Jharkhand
झारखण्ड

Correct Answer: Madhya Pradesh
मध्य प्रदेश

Candidate Answer: Maharashtra
महाराष्ट्र

Question 41. C. P. U. consists of

सी. पी. यू. में _____ होता है।

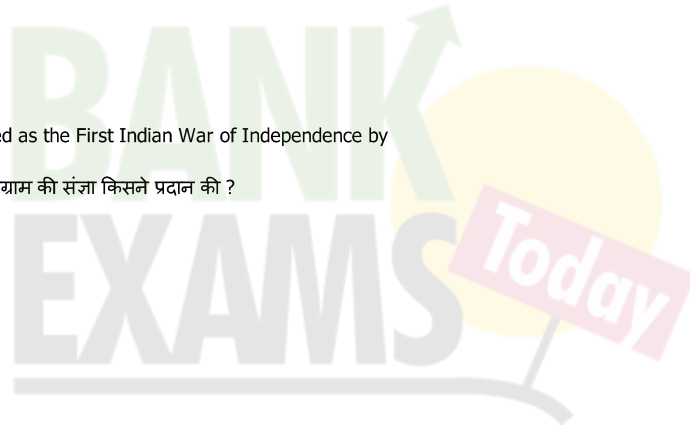

Options:

- 1) Arithmetic and Logical unit and Register
अरिथमेटिक व लॉजिकल यूनिट व रजिस्टर
- 2) Arithmetic and Logical unit, Register and Control unit
अरिथमेटिक व लॉजिकल यूनिट , रजिस्टर तथा कंट्रोल यूनिट
- 3) System unit and Memory
सिस्टम यूनिट तथा मेमोरी
- 4) Hard disk and Control unit
हार्ड डिस्क तथा कंट्रोल यूनिट

Correct Answer: Arithmetic and Logical unit, Register and Control unit
अरिथमेटिक व लॉजिकल यूनिट , रजिस्टर तथा कंट्रोल यूनिट

Candidate Answer: Arithmetic and Logical unit, Register and Control unit
अरिथमेटिक व लॉजिकल यूनिट , रजिस्टर तथा कंट्रोल यूनिट

Question 42. Which of the following is not connective tissue?

निम्नलिखित में से कौन सा संयोजक ऊतक नहीं है ?

Options:

- 1) Bone
अस्थि
- 2) Cartilage
उपास्थि
- 3) Blood
रक्त
- 4) Skeletal muscle
कंकाल पेशी

Correct Answer: Skeletal muscle
कंकाल पेशी

Candidate Answer: [NOT ANSWERED]

Question 43. Every hot object emits _____

प्रत्येक गर्म वस्तु से _____ का उत्सर्जन होता है।

Options:

- 1) X - rays
एक्स रेज़
- 2) Visible light
दृश्य प्रकाश
- 3) Infrared rays
अवरक्त किरणें
- 4) Ultraviolet rays
पराबैंगनी किरणें

Correct Answer: Infrared rays
अवरक्त किरणें

Candidate Answer: [NOT ANSWERED]

Question 44. Ozone protects biosphere from _____

ओज़ोन जीवमंडल को _____ से बचाती है।

Options:

- 1) X - rays
एक्स रेज़
- 2) Gamma rays
गामा रेज़
- 3) Ultraviolet rays
पराबैंगनी किरणें
- 4) Infrared rays
अवरक्त किरणें

Correct Answer: Ultraviolet rays
पराबैंगनी किरणें

Candidate Answer: Ultraviolet rays
पराबैंगनी किरणें

Question 45. The molecular mass of a gas is _____

किसी गैस का आणविक द्रव्यमान _____ होता है।

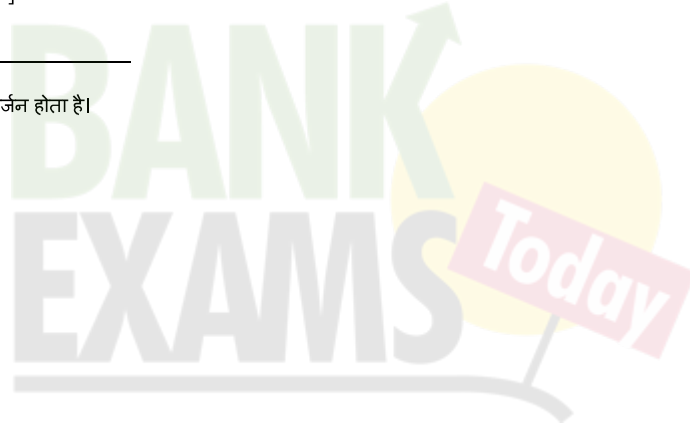

Options:

- 1) twice its vapour pressure
उसके वाष्पदाब से दुगुना
- 2) equal to its vapour pressure
उसके वाष्पदाब के बराबर
- 3) half its vapour pressure
उसके वाष्पदाब से आधा
- 4) not related to its vapour pressure
उसके वाष्पदाब से असम्बद्ध

Correct Answer: twice its vapour pressure

उसके वाष्पदाब से दुगुना

Candidate Answer: equal to its vapour pressure

उसके वाष्पदाब के बराबर

Question 46.'Stand up India' scheme launched by the Prime Minister recently is related with

हाल ही में प्रधान मंत्री द्वारा प्रारम्भ ' स्टैंड अप इंडिया' स्कीम का सम्बन्ध किससे है ?

Options:

- 1) Promotion of entrepreneurship among SC, ST and Women
अनुसूचित जातियों, अनुसूचित जनजातियों व स्त्रियों में उद्यमिता के प्रोत्साहन से
- 2) Promotion of rights of Divyangs
दिव्यांगों के अधिकारों के प्रोत्साहन से
- 3) Promotion of compulsory education for women
स्त्रियों के लिए अनिवार्य शिक्षा के प्रोत्साहन से
- 4) Promotion of Indian exports in western countries
पश्चिमी देशों को भारतीय निर्यात के प्रोत्साहन से

Correct Answer: Promotion of entrepreneurship among SC, ST and Women

अनुसूचित जातियों, अनुसूचित जनजातियों व स्त्रियों में उद्यमिता के प्रोत्साहन से

Candidate Answer: Promotion of entrepreneurship among SC, ST and Women

अनुसूचित जातियों, अनुसूचित जनजातियों व स्त्रियों में उद्यमिता के प्रोत्साहन से

Question 47.Which one of the following institutions is also called "World Bank" ?

निम्नलिखित में से कौन सी संस्था ' वर्ल्ड बैंक ' के नाम से भी जानी जाती है ?

Options:

- 1) International Bank of Reconstruction and Development
इंटरनेशनल बैंक फॉर रिकंस्ट्रक्शन एंड डिवलपमेंट
- 2) International Monetary Fund
इंटरनेशनल मॉनिटरी फंड
- 3) UNICEF
यूनिसेफ
- 4) IFC
आई एफ सी

Correct Answer: International Bank of Reconstruction and Development

इंटरनेशनल बैंक फॉर रिकंस्ट्रक्शन एंड डिवलपमेंट

Candidate Answer: International Bank of Reconstruction and Development

इंटरनेशनल बैंक फॉर रिकंस्ट्रक्शन एंड डिवलपमेंट

Question 48.Which is called the "Lake District of India"?

निम्नलिखित में से कौन भारत के ' लेक डिस्ट्रीक्ट ' के रूप में जाना जाता है ?

Options:

- 1) Nainital
नैनीताल
- 2) Shimla
शिमला
- 3) Sikkim
सिक्किम
- 4) Matheran
माथेरन

Correct Answer: Nainital

नैनीताल

Candidate Answer: Nainital

नैनीताल

Question 49.Which of the following sets of taxes belongs to Central Government?

निम्नलिखित में से कौन सा समुच्चय केन्द्रीय सरकार से सम्बद्ध है ?

Options:

1) Excise duty, Sales tax and Custom duty

आबकारी कर, बिक्री कर व सीमा शुल्क

2) Income tax, Custom duty and House tax

आयकर, सीमाशुल्क व गृहकर

3) Excise duty, Custom duty and Income tax

आबकारी कर, सीमाशुल्क व आयकर

4) Custom duty, Entertainment tax and Income tax

सीमाशुल्क, मनोरंजन कर व आयकर

Correct Answer: Excise duty, Custom duty and Income tax

आबकारी कर, सीमाशुल्क व आयकर

Candidate Answer: Excise duty, Sales tax and Custom duty

आबकारी कर, बिक्री कर व सीमा शुल्क

Question 50. Brown stains in vessels and clothes indicate the presence of _____ in water

बर्तनों तथा कपड़ों पर बादामी धब्बे पानी में _____ की अत्यधिक मात्रा के संकेतक हैं

Options:

1) Magnesium

मैग्नीशियम

2) Calcium

कैल्शियम

3) Manganese

मैंगनीज़

4) Chromium

क्रोमियम

Correct Answer: Manganese

मैंगनीज़

Candidate Answer: Magnesium

मैग्नीशियम

Question 51. The radius of a sphere and right circular cylinder is 'r'. Their volumes are equal. The ratio of the height and radius of the cylinder is:

एक गोलक और एक लंब वृत्तीय बेलन की त्रिज्या 'r' है। उनके आयतन बराबर हैं। बेलन की ऊँचाई और त्रिज्या का अनुपात ज्ञात कीजिए ?

Options:

1) 3:1

2) 2:1

3) 3:2

4) 4:3

Correct Answer: 4:3**Candidate Answer:** 4:3

Question 52. When a discount of Rs. 42 is allowed on the marked price of an article, the new reduced price becomes 86% of the original price. Find the marked price.

यदि किसी वस्तु के अंकित मूल्य पर Rs. 42 की छूट दी जाती है तो नई घटी हुई कीमत, मूल कीमत की 86% हो जाती है। अंकित कीमत ज्ञात कीजिए ?

Options:

1) Rs.250

2) Rs.300

3) Rs.350

4) Rs.400

Correct Answer: Rs.300**Candidate Answer:** Rs.300

Question 53. A merchant buys 25 litres of milk daily at the rate of ₹ 12 per litre. He mixes 5 litres of water in it and sells at the rate of ₹ 10.40 per litre. His gain/loss is:

एक दुकानदार प्रति दिन 25 लीटर दूध ₹ 12 प्रति लीटर की दर से खरीदता है। उसमें वह 5 लीटर पानी मिलाकर ₹ 10.40 प्रति लीटर की दर से बेच देता है। तदनुसार उसके लाभ/हानि का प्रतिशत कितना है ?

Options:

1) 8% profit

8% लाभ

2) 2% profit

2% लाभ

3) 4% profit

4% लाभ

4) 6% profit

6% लाभ

Correct Answer: 4% profit
4% लाभ

Candidate Answer: 4% profit
4% लाभ

Question 54. A man spends 15% of his income. If his expenditure is Rs. 75, his income (in rupees) is:

एक व्यक्ति अपनी आय का 15% खर्च कर देता है। यदि उसका खर्च Rs. 75 हो, तो उसकी आय (रुपयों में) जात कीजिए ?

Options:

1) 400

2) 300

3) 750

4) 500

Correct Answer: 500

Candidate Answer: 500

Question 55. To cover a certain distance with a speed of 60 km/hr, a train takes 15 hours. If it covers the same distance in 12 hours, what will be its speed?

एक रेलगाड़ी जो 60 कि.मी./घंटा की रफ्तार से चल रही है, एक निश्चित दूरी को तय करने में 15 घंटे का समय लेती है। यदि वह वही दूरी 12 घंटे में तय करे तो उसकी चाल क्या होगी ?

Options:

1) 65 km/h

65 कि.मी. /घंटा

2) 70 km/h

70 कि.मी./घंटा

3) 75 km/h

75 कि.मी./घंटा

4) 80 km/h

80 कि.मी./घंटा

Correct Answer: 75 km/h

75 कि.मी./घंटा

Candidate Answer: 75 km/h

75 कि.मी./घंटा

Question 56. Sum of three consecutive integers is 51 . The middle one is:

तीन क्रमागत पूर्णांकों का योग 51 है। बीच वाली संख्या क्या है ?

Options:

1) 14

2) 15

3) 16

4) 17

Correct Answer: 17

Candidate Answer: 17

Question 57.

If $x + \frac{1}{x} = 5$, then the value of $\frac{5x}{x^2+5x+1}$ is

यदि $x + \frac{1}{x} = 5$, तो $\frac{5x}{x^2+5x+1}$ का मान बताएं?

Options:

1) $\frac{1}{3}$

2) $\frac{1}{4}$

3) $\frac{1}{2}$

4) $\frac{1}{5}$

Correct Answer: $\frac{1}{2}$

Candidate Answer: $\frac{1}{2}$

Question 58. The point of intersection of all the three medians of a triangle is called its

किसी त्रिकोण की तीनों माध्यिकाओं को काटने वाले बिन्दु को क्या कहते हैं ?

Options:

1) orthocentre

लंबकेन्द्र

2) incentre

अंतः केन्द्र

3) centroid

केन्द्रक

4) circumcentre

परिकेन्द्र

Correct Answer: centroid

केन्द्रक

Candidate Answer: centroid

केन्द्रक

Question 59. The area of a triangle with vertices A (0, 8), O (0,0) and B (5, 0) is:

ऐसे त्रिकोण, जिसके ऊर्ध्व A (0,8), O (0,0), और B (5,0) हो, तो क्षेत्रफल क्या होगा ?

Options:

1) 8 sq. units

8 वर्ग यूनिट

2) 13 sq. units

13 वर्ग यूनिट

3) 20 sq. units

20 वर्ग यूनिट

4) 40 sq. units

40 वर्ग यूनिट

Correct Answer: 20 sq. units

20 वर्ग यूनिट

Candidate Answer: 20 sq. units

20 वर्ग यूनिट

Question 60. The least number that must be subtracted from 1294 so that the remainder when divided by 9, 11, 13 will leave in each case the same remainder 6 is:

वह न्यूनतम संख्या ज्ञात कीजिए जिसे 1294 में से घटाने पर और फिर शेष बची संख्या को 9,11,13 तीनों से भाग देने पर प्रत्येक बार 6 शेष बचे ?

Options:

1) 2

2) 3

3) 1

4) 4

Correct Answer: 1**Candidate Answer:** 1

Question 61. A and B can do a piece of work in 72 days. B and C can do it in 120 days and A and C can do it in 90 days. A alone can do it in:

A और B किसी काम को 72 दिन में कर सकते हैं। B और C उसी काम को 120 दिन में कर सकते हैं। तथा A और C मिलकर उसे 90 दिन में कर सकते हैं। बताइए A अकेला उस काम को कितने दिन में करेगा ?

Options:

1) 120 days

120 दिन

2) 130 days

130 दिन

3) 150 days

150 दिन

4) 100 days

100 दिन

Correct Answer: 120 days

120 दिन

Candidate Answer: 120 days

120 दिन

Question 62. Rs. 730 were divided among A, B, C in such a way that if A gets Rs. 3 then B gets Rs. 4 and if B gets Rs. 3.50 then C gets Rs. 3. The share of B exceeds that of C by

Rs. 730 की राशि A, B, C के बीच इस प्रकार विभाजित की गई है कि यदि A को Rs. 3 मिले तो B को Rs. 4 मिले और यदि B को Rs. 3.50 मिले तो C को Rs. 3 मिले। B का हिस्सा, C से कितना अधिक है ?

Options:

1) Rs.30

2) Rs.40

3) Rs.70

4) Rs.210

Correct Answer: Rs.40**Candidate Answer:** Rs.40

Question 63. The average marks obtained in a class of 50 students is 70%. The average of first 25 is 60% and that of 24 is 80%. What is the marks obtained by the last student?

50 छात्रों की कक्षा में औसतन 70% अंक प्राप्त किए गए। प्रथम 25 छात्रों ने औसतन 60 % अंक प्राप्त किए और 24 छात्रों ने औसतन 80% अंक प्राप्त किए। अंतिम छात्र ने कितने अंक प्राप्त किए ?

Options:

1) 90%

2) 60%

3) 80%

4) 70%

Correct Answer: 80%**Candidate Answer:** 80%

Question 64.

If $\frac{1}{a}(a^2 + 1) = 3$, then the value of $\frac{a^6 + 1}{a^3}$ is

यदि $(1/a)(a^2 + 1) = 3$ हो, तो

$\frac{a^6 + 1}{a^3}$ का मान ज्ञात कीजिए ?

Options:

1) 9

2) 18

3) 27

4) 1

Correct Answer: 18**Candidate Answer:** 18

Question 65.

If $a = \sqrt{2} + 1, b = \sqrt{2} - 1$,
then the value of $\frac{1}{a+1} + \frac{1}{b+1}$ is

यदि $a = \sqrt{2} + 1, b = \sqrt{2} - 1$ हो तो $\frac{1}{a+1} + \frac{1}{b+1}$ का मान बताएं?

Options:

1) 0

2) 1

3) 2

4) 3

Correct Answer: 1**Candidate Answer:** 1

Question 66. In a triangle, the distance of the centroid from the three vertices is 4cm, 6cm and 8cm respectively. Then the length of the smallest median is:

किसी त्रिकोण में तीनों ऊर्ध्वों से केन्द्रक की दूरी क्रमशः 4 से.मी., 6 से.मी. और 8 से.मी. हैं। सबसे छोटी माध्यिका की लम्बाई ज्ञात कीजिए ?

Options:

1) 8

2) 7

3) 6

4) 5

Correct Answer: 6**Candidate Answer:** 6

Question 67. O is the centre of the circle and $\angle AOB = 150^\circ$, and the shaded portion is x part of the circular region, then $x = ?$

यदि वृत्त का केन्द्र O हो और $\angle AOB = 150^\circ$, और छायादार भाग वृत्तीय क्षेत्र का x भाग हो, तो x का मान क्या होगा ?

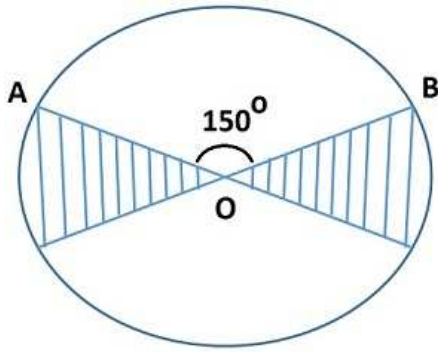

Options:

1) $\frac{1}{12}$

2) $\frac{1}{9}$

3) $\frac{1}{6}$

4) $\frac{1}{4}$

Correct Answer: $\frac{1}{6}$

Candidate Answer: $\frac{1}{6}$

Question 68.

θ is a positive acute angle and $\sin\theta - \cos\theta = 0$, then the value of $\sec\theta + \operatorname{cosec}\theta$ is

θ एक धनात्मक न्यून कोण है और $\sin\theta - \cos\theta = 0$ हो, तो $\sec\theta + \operatorname{cosec}\theta$ का मान ज्ञात कीजिए ?

Options:

1) 2

2) $\sqrt{2}$

3) $2\sqrt{2}$

4) $3\sqrt{2}$

Correct Answer:

$2\sqrt{2}$

Candidate Answer:

$2\sqrt{2}$

Question 69.

The value of $\frac{2 \tan 53^\circ}{\cot 37^\circ} - \frac{\cot 80^\circ}{\tan 10^\circ}$ is

$\frac{2 \tan 53^\circ}{\cot 37^\circ} - \frac{\cot 80^\circ}{\tan 10^\circ}$ का मान बताएं ?

Options:

1) 3

2) 2

3) 1

4) 0

Correct Answer: 1

Candidate Answer: 1

Question 70. The compound interest on Rs. 24000 at 10% per annum for $1\frac{1}{2}$ years, interest being compounded semi-annually is

डेढ़ ($1\frac{1}{2}$) वर्ष के लिए 10% वार्षिक की दर से Rs. 24000 की राशि पर चक्रवृद्धि ब्याज (अर्धवार्षिक अन्तराल पर संयोजित) बताइए ?

Options:

1) Rs.3783

2) Rs.3777

3) Rs.3780

4) Rs.3781

Correct Answer: Rs.3783

Candidate Answer: Rs.3783

Question 71. A boat is moving away from an observation tower. It makes an angle of depression of 60° with an observer's eye when at a distance of 50m from the tower. After 8 sec., the angle of depression becomes 30° . By assuming that it is running in still water, the approximate speed of the boat is

एक नाव किसी प्रेक्षण टावर से दूर जा रही है। जब वह टॉवर से 50 मीटर की दूरी पर है तो वह प्रेक्षक की दृष्टि में 60° का अवनमन कोण बनाती है। 8 सेकण्ड के बाद अवनमन कोण 30° का हो जाता है, तो यह मानते हुए कि नाव ठहरे हुए पानी में चल रही है। नाव की लगभग चाल (स्पीड) बताइए ?

Options:

1) 33km/hr

33 कि.मी./घंटा

2) 42km/hr

42 कि.मी./घंटा

3) 45km/hr

45 कि.मी./घंटा

4) 50km/hr

50 कि.मी./घंटा

Correct Answer: 45km/hr

45 कि.मी./घंटा

Candidate Answer: 45km/hr

45 कि.मी./घंटा

Question 72. The bar graph given indicates the income of a firm. Study the graph and answer the questions given.

यहाँ दिया गया बार ग्राफ एक कम्पनी की आय को दर्शाता है। बार-ग्राफ का अध्ययन कीजिए और प्रश्नों के उत्तर दीजिए।

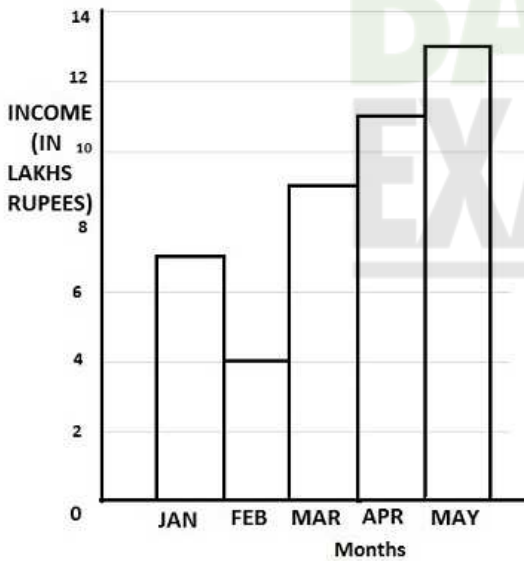

Which period shows a steady increase of income ?

किस अन्तराल में आय में निरन्तर बढ़ोत्तरी हुई है ?

Options:

1) March to May

मार्च से मई तक

2) February to April

फरवरी से अप्रैल तक

3) February to May

फरवरी से मई तक

4) Insufficient data to predict

आँकड़े अपर्याप्त है।

Correct Answer: March to May

मार्च से मई तक

Candidate Answer: February to May

फरवरी से मई तक

Question 73. The bar graph given indicates the income of a firm. Study the graph and answer the questions given.

यहाँ दिया गया बार ग्राफ एक कम्पनी की आय को दर्शाता है। बार-ग्राफ का अध्ययन कीजिए और प्रश्नों के उत्तर दीजिए।

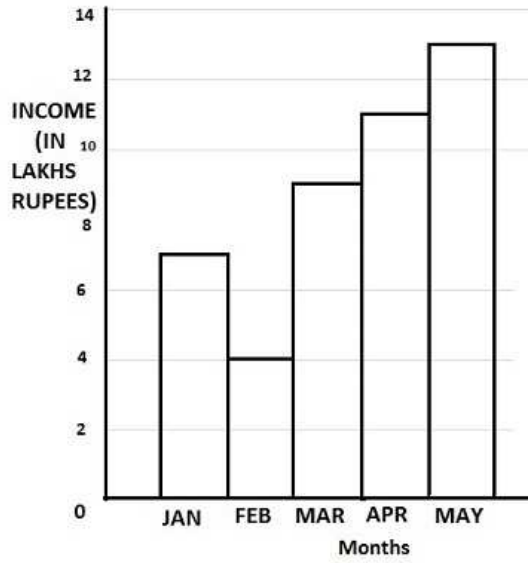

During which month, the ratio of the income to that of the previous month is the largest?

किस माह में आय का पूर्व माह की आय से अनुपात अधिकतम है ?

Options:

1) February

फरवरी

2) March

मार्च

3) April

अप्रैल

4) May

मई

Correct Answer: March

मार्च

Candidate Answer: March

मार्च

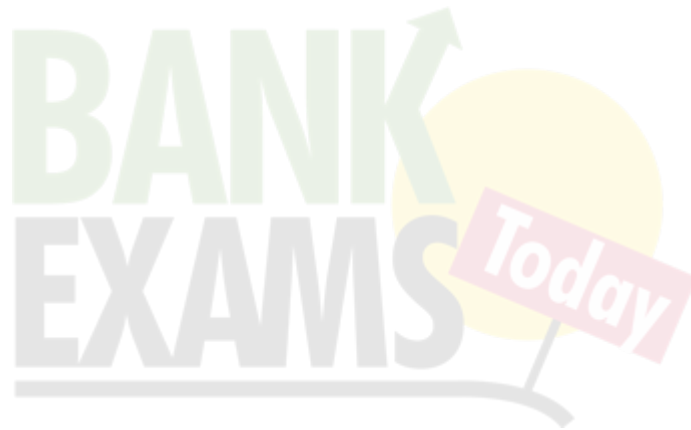

Question 74. The bar graph given indicates the income of a firm. Study the graph and answer the questions given.

यहाँ दिया गया बार ग्राफ एक कम्पनी की आय को दर्शाता है। बार-ग्राफ का अध्ययन कीजिए और प्रश्नों के उत्तर दीजिए।

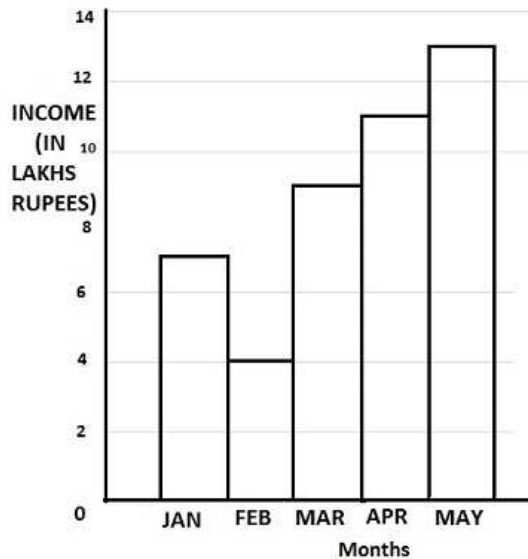

The income in May is how many times to that of February?

मई की आय फरवरी की आय की कितनी गुना है ?

Options:

1) 3.25

2) 4

3) 3.5

4) 5

Correct Answer: 3.25

Candidate Answer: 3.25

Question 75. The bar graph given indicates the income of a firm. Study the graph and answer the questions given.

यहाँ दिया गया बार ग्राफ एक कम्पनी की आय को दर्शाता है। बार-ग्राफ का अध्ययन कीजिए और प्रश्नों के उत्तर दीजिए।

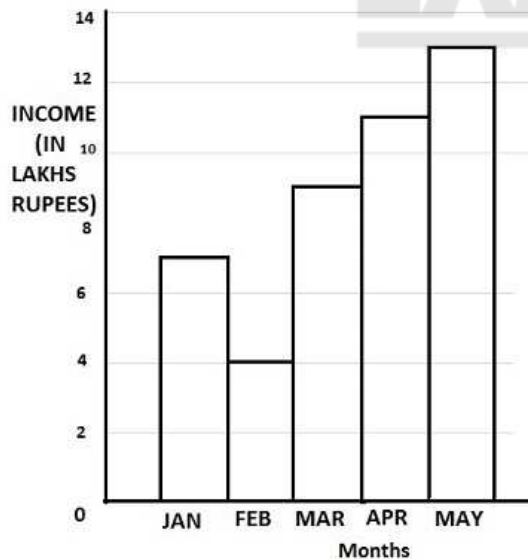

The average monthly income of the firm (in lakh rupees) is

कम्पनी की औसत मासिक आय (लाख रुपयों में) क्या है?

Options:

1) 7.6

2) 6

3) 8.8

4) None of these

इनमें से कोई नहीं

Correct Answer: 8.8

Candidate Answer: 8.8

Question 76. In the following question, out of the four alternatives, choose the word which best expresses the meaning of the given word and click the button corresponding to it.

HOODWINK

Options:

- 1) DECEIVE
- 2) NEGATE
- 3) UPSET
- 4) COVER

Correct Answer: DECEIVE

Candidate Answer: [NOT ANSWERED]

Question 77. In the following question, out of the four alternatives, choose the word which is opposite in meaning to the given word and click the button corresponding to it.

FUTILE

Options:

- 1) DISTINCT
- 2) OPEN
- 3) PLEASED
- 4) FRUITFUL

Correct Answer: FRUITFUL

Candidate Answer: [NOT ANSWERED]

Question 78. Four words are given, out of which only one word is spelt correctly. Choose the correctly spelt word and click the button corresponding to it.

Options:

- 1) Aggression
- 2) Agression
- 3) Aggreition
- 4) Aggesion

Correct Answer: Aggression

Candidate Answer: Aggression

Question 79. In the following questions, one part of the sentence may have an error. Find out which part of the sentence has an error and click the button corresponding to it. If the sentence is free from error, click the "No error" option.

She does not listen to me (A) / because she is (B) / senior than me (C) / No Error (D)

Options:

- 1) A
- 2) B
- 3) C
- 4) D

Correct Answer: C

Candidate Answer: D

Question 80. In the following questions, one part of the sentence may have an error. Find out which part of the sentence has an error and click the button corresponding to it. If the sentence is free from error, click the "No error" option.

The man is (A) / the most tallest (B) / of the group (C) / No Error (D)

Options:

- 1) A
- 2) B
- 3) C
- 4) D

Correct Answer: B

Candidate Answer: B

Question 81. In the following questions, one part of the sentence may have an error. Find out which part of the sentence has an error and click the button corresponding to it. If the sentence is free from error, click the "No error" option.

The boy (A) / which money (B) / was lost felt sorry (C) / No Error (D)

Options:

- 1) A
- 2) B
- 3) C
- 4) D

Correct Answer: B

Candidate Answer: C

Question 82. The sentences given with blanks are to be filled with an appropriate word(s). Four alternatives are suggested for each question. For each question, choose the correct alternative and click the button corresponding to it.

This is the wrong _____ to this question .

Options:

- 1) saying
- 2) style
- 3) reaction
- 4) answer

Correct Answer: answer

Candidate Answer: answer

Question 83.The sentences given with blanks are to be filled with an appropriate word(s). Four alternatives are suggested for each question. For each question, choose the correct alternative and click the button corresponding to it.

The resort is _____ the lake.

Options:

- 1) from
- 2) has
- 3) besides
- 4) beside

Correct Answer: beside

Candidate Answer: besides

Question 84.The sentences given with blanks are to be filled with an appropriate word(s). Four alternatives are suggested for each question. For each question, choose the correct alternative and click the button corresponding to it.

The life of a mosquito is _____ , but very active.

Options:

- 1) long
- 2) passive
- 3) brief
- 4) important

Correct Answer: brief

Candidate Answer: passive

Question 85.In each of the questions, four alternatives are given for the Idiom/Phrase. Choose the alternative which best expresses the meaning of the Idiom/Phrase and click the button corresponding to it.

Capital Punishment

Options:

- 1) Death sentence
- 2) Life imprisonment
- 3) To be jailed
- 4) Imprisoned for a long period

Correct Answer: Death sentence

Candidate Answer: Life imprisonment

Question 86.In each of the questions, four alternatives are given for the Idiom/Phrase. Choose the alternative which best expresses the meaning of the Idiom/Phrase and click the button corresponding to it.

Leaps and bounds

Options:

- 1) Slowly
- 2) Rapidly
- 3) Jumping
- 4) Stationary

Correct Answer: Rapidly

Candidate Answer: Rapidly

Question 87.In each of the questions, four alternatives are given for the Idiom/Phrase. Choose the alternative which best expresses the meaning of the Idiom/Phrase and click the button corresponding to it.

Smell a rat

Options:

- 1) Suspect something wrong
- 2) Smell a burned rat
- 3) Smell a rotten rat
- 4) Smell something right

Correct Answer: Suspect something wrong

Candidate Answer: Suspect something wrong

Question 88.Out of the four alternatives, choose the one which can be substituted for the given words/sentences and click the button corresponding to it.

Government by a king

Options:

- 1) Autocracy
- 2) Aristocracy
- 3) Oligarchy
- 4) Monarchy

Correct Answer: Monarchy

Candidate Answer: Monarchy

Question 89.Out of the four alternatives, choose the one which can be substituted for the given words/sentences and click the button corresponding to it.

Hobson's choice

Options:

- 1) Choice to live or die
- 2) Excellent choice
- 3) No choice at all
- 4) Bigman's choice

Correct Answer: No choice at all**Candidate Answer:** No choice at all

Question 90. Out of the four alternatives, choose the one which can be substituted for the given words/sentences and click the button corresponding to it.

Violation of the sanctity of a sacred place

Options:

- 1) Sin
- 2) Sacrilege
- 3) Sedition
- 4) Blasphemy

Correct Answer: Sacrilege**Candidate Answer:** [NOT ANSWERED]

Question 91. A sentence/a part of the sentence is underlined. Four alternatives are given to the underlined part which will improve the sentence. Choose the correct alternative and click the button corresponding to it. In case no improvement is needed, click the button corresponding to "No improvement".

A chance remark by her friend transported her life.

Options:

- 1) transgressed
- 2) transposed
- 3) transformed
- 4) No improvement

Correct Answer: transformed**Candidate Answer:** transformed

Question 92. A sentence/a part of the sentence is underlined. Four alternatives are given to the underlined part which will improve the sentence. Choose the correct alternative and click the button corresponding to it. In case no improvement is needed, click the button corresponding to "No improvement".

Please switch of the fan.

Options:

- 1) switch off
- 2) switch in
- 3) switch out
- 4) No improvement

Correct Answer: switch off**Candidate Answer:** switch off

Question 93. A sentence/a part of the sentence is underlined. Four alternatives are given to the underlined part which will improve the sentence. Choose the correct alternative and click the button corresponding to it. In case no improvement is needed, click the button corresponding to "No improvement".

The employees are hell bent at getting what is due to them.

Options:

- 1) hell bent on getting
- 2) hell bent for getting
- 3) hell bent about getting
- 4) No improvement

Correct Answer: hell bent on getting**Candidate Answer:** hell bent about getting

Question 94. A sentence/a part of the sentence is underlined. Four alternatives are given to the underlined part which will improve the sentence. Choose the correct alternative and click the button corresponding to it. In case no improvement is needed, click the button corresponding to "No improvement".

The new book written by Vikram Seth has become very populous.

Options:

- 1) populist
- 2) popular
- 3) populace
- 4) No improvement

Correct Answer: popular**Candidate Answer:** popular

Question 95. A sentence/a part of the sentence is underlined. Four alternatives are given to the underlined part which will improve the sentence. Choose the correct alternative and click the button corresponding to it. In case no improvement is needed, click the button corresponding to "No improvement".

Where have you first met your husband?

Options:

- 1) had you first met
- 2) did you first met
- 3) did you first meet
- 4) No improvement

Correct Answer: did you first meet**Candidate Answer:** did you first meet

Question 96. A passage is given with 5 questions following it. Read the passage carefully and choose the best answer to each question out of the four alternatives and click the button corresponding to it.

Man's attitude to various animals changed many times in the course of centuries. From indifference or practicality, he went on to adoration and deification, and then to hatred. Ancient Egyptians, for example, highly appreciated the cat's ability to destroy rodents. The cat was much superior in this respect to the grass-snakes and weasels they had kept in their houses before. These proved unable to cope with hordes of rats which invaded Egypt from Asia. So the cat, a very useful animal, was ranked as a sacred animal and one of the most important animals, too. The goddess of the Moon, fertility and child-birth, Bast herself was portrayed by the Egyptians as a woman with a cat's head.

Sumptuous temples were built to this goddess, where cats were kept in luxury and fed the choicest of foods. They had their own priests and votaries, more numerous as a matter of fact than any other sacred animal could boast. According to the Greek historian Herodotus, the festival in the city of Bubastis, which had a temple dedicated to cats, was attended by as many as 700 thousand, who brought their offerings to the goddess in the shape of figurines of her made of gold, silver and bronze and adorned with precious stones.

Egyptians appreciated the cat's ability to destroy ____ .

Options:

- 1) snakes
- 2) weasels
- 3) houses
- 4) rodents

Correct Answer: rodents

Candidate Answer: rodents

Question 97. A passage is given with 5 questions following it. Read the passage carefully and choose the best answer to each question out of the four alternatives and click the button corresponding to it.

Man's attitude to various animals changed many times in the course of centuries. From indifference or practicality, he went on to adoration and deification, and then to hatred. Ancient Egyptians, for example, highly appreciated the cat's ability to destroy rodents. The cat was much superior in this respect to the grass-snakes and weasels they had kept in their houses before. These proved unable to cope with hordes of rats which invaded Egypt from Asia. So the cat, a very useful animal, was ranked as a sacred animal and one of the most important animals, too. The goddess of the Moon, fertility and child-birth, Bast herself was portrayed by the Egyptians as a woman with a cat's head.

Sumptuous temples were built to this goddess, where cats were kept in luxury and fed the choicest of foods. They had their own priests and votaries, more numerous as a matter of fact than any other sacred animal could boast. According to the Greek historian Herodotus, the festival in the city of Bubastis, which had a temple dedicated to cats, was attended by as many as 700 thousand, who brought their offerings to the goddess in the shape of figurines of her made of gold, silver and bronze and adorned with precious stones.

Hordes of rats invaded Egypt. They came from ____ .

Options:

- 1) Europe
- 2) Asia
- 3) Asia Minor
- 4) Africa

Correct Answer: Asia

Candidate Answer: Asia

Question 98. A passage is given with 5 questions following it. Read the passage carefully and choose the best answer to each question out of the four alternatives and click the button corresponding to it.

Man's attitude to various animals changed many times in the course of centuries. From indifference or practicality, he went on to adoration and deification, and then to hatred. Ancient Egyptians, for example, highly appreciated the cat's ability to destroy rodents. The cat was much superior in this respect to the grass-snakes and weasels they had kept in their houses before. These proved unable to cope with hordes of rats which invaded Egypt from Asia. So the cat, a very useful animal, was ranked as a sacred animal and one of the most important animals, too. The goddess of the Moon, fertility and child-birth, Bast herself was portrayed by the Egyptians as a woman with a cat's head.

Sumptuous temples were built to this goddess, where cats were kept in luxury and fed the choicest of foods. They had their own priests and votaries, more numerous as a matter of fact than any other sacred animal could boast. According to the Greek historian Herodotus, the festival in the city of Bubastis, which had a temple dedicated to cats, was attended by as many as 700 thousand, who brought their offerings to the goddess in the shape of figurines of her made of gold, silver and bronze and adorned with precious stones.

The cat was considered to be a ____ .

Options:

- 1) sacred animal
- 2) goddess
- 3) symbol of peace
- 4) symbol of fertility

Correct Answer: sacred animal

Candidate Answer: sacred animal

Question 99. A passage is given with 5 questions following it. Read the passage carefully and choose the best answer to each question out of the four alternatives and click the button corresponding to it.

Man's attitude to various animals changed many times in the course of centuries. From indifference or practicality, he went on to adoration and deification, and then to hatred. Ancient Egyptians, for example, highly appreciated the cat's ability to destroy rodents. The cat was much superior in this respect to the grass-snakes and weasels they had kept in their houses before. These proved unable to cope with hordes of rats which invaded Egypt from Asia. So the cat, a very useful animal, was ranked as a sacred animal and one of the most important animals, too. The goddess of the Moon, fertility and child-birth, Bast herself was portrayed by the Egyptians as a woman with a cat's head.

Sumptuous temples were built to this goddess, where cats were kept in luxury and fed the choicest of foods. They had their own priests and votaries, more numerous as a matter of fact than any other sacred animal could boast. According to the Greek historian Herodotus, the festival in the city of Bubastis, which had a temple dedicated to cats, was attended by as many as 700 thousand, who brought their offerings to the goddess in the shape of figurines of her made of gold, silver and bronze and adorned with precious stones.

What is the opposite of the word 'votaries' ?

Options:

- 1) Enthusiast
- 2) Critic
- 3) Adherent
- 4) Fanatic

Correct Answer: Critic**Candidate Answer:** Critic

Question 100. A passage is given with 5 questions following it. Read the passage carefully and choose the best answer to each question out of the four alternatives and click the button corresponding to it.

Man's attitude to various animals changed many times in the course of centuries. From indifference or practicality, he went on to adoration and deification, and then to hatred. Ancient Egyptians, for example, highly appreciated the cat's ability to destroy rodents. The cat was much superior in this respect to the grass-snakes and weasels they had kept in their houses before. These proved unable to cope with hordes of rats which invaded Egypt from Asia. So the cat, a very useful animal, was ranked as a sacred animal and one of the most important animals, too. The goddess of the Moon, fertility and child-birth, Bast herself was portrayed by the Egyptians as a woman with a cat's head.

Sumptuous temples were built to this goddess, where cats were kept in luxury and fed the choicest of foods. They had their own priests and votaries, more numerous as a matter of fact than any other sacred animal could boast. According to the Greek historian Herodotus, the festival in the city of Bubastis, which had a temple dedicated to cats, was attended by as many as 700 thousand, who brought their offerings to the goddess in the shape of figurines of her made of gold, silver and bronze and adorned with precious stones.

The word 'deification' in the passage means _____ .

Options:

- 1) highly valuable
- 2) take pride
- 3) act of treating as God
- 4) devotees

Correct Answer: act of treating as God**Candidate Answer:** act of treating as God